

# **e**machines<sup>®</sup>



**e17t4w**  
**User Guide**



# Contents

---

<b>Using Your eMachines Flat-panel Monitor .....</b>	<b>1</b>
Connecting the monitor .....	2
Setting up the optional stand .....	3
Attaching the USB stand .....	3
Adjusting monitor height tension .....	7
Adjusting monitor tilt tension .....	8
Connecting the USB hub .....	9
Setting up the optional speaker bar .....	10
Installing the speaker bar .....	10
Starting the monitor .....	11
Adjusting monitor settings .....	12
Monitor buttons .....	12
On-screen display options .....	13
Adjusting Windows display settings .....	15
Changing settings in Windows Vista .....	16
Changing settings in Windows XP .....	17
Video modes .....	19
Power management .....	19
ENERGY STAR .....	19
Energy declaration .....	20
Maintaining .....	20
Troubleshooting .....	21
No power .....	21
No picture .....	21
Monitor colors are wrong .....	21
Picture has shadows or “ghosts” .....	22
Color is not uniform .....	22
Image is not sized or centered correctly .....	22
The monitor has pixels that are always dark or too bright .....	22
Speaker bar does not work .....	22
Specifications .....	24
<b>Safety, Regulatory, and Legal Information .....</b>	<b>25</b>
Recycling .....	27
EPA ENERGY STAR .....	27



# Chapter 1

## Using Your eMachines Flat-panel Monitor

- Connecting the monitor
- Setting up the optional stand
- Setting up the optional speaker bar
- Starting the monitor
- Adjusting monitor settings
- Adjusting Windows display settings
- Power management
- Maintaining
- Troubleshooting
- Specifications

## Connecting the monitor

▶ **To connect the monitor:**

- 1 Place the monitor base on a table top, then slide the monitor neck down onto the base until it clicks into place. You may need to press the two buttons on the base to let the monitor slide on smoothly.

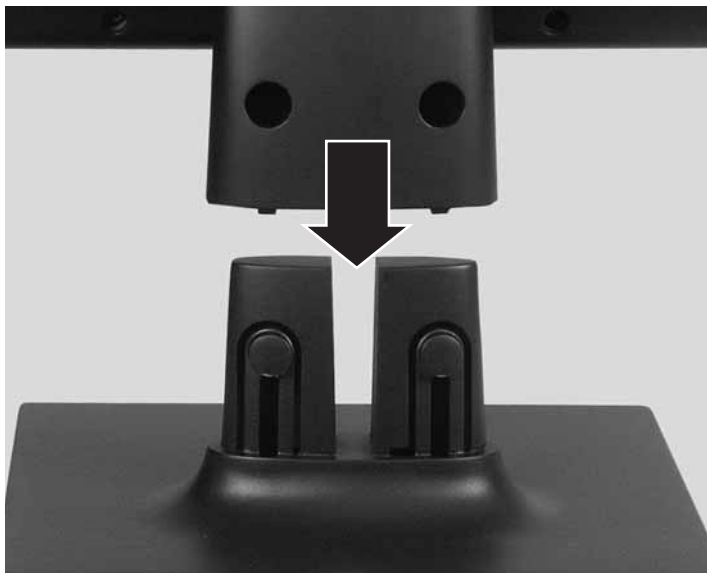

- 2 Position your computer and the monitor so you can reach the back of each.
- 3 Connect the power cord to the power connector under the back of the display.

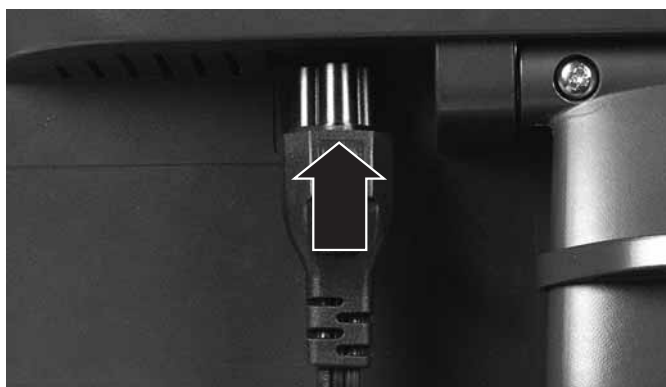

- 4 Connect the blue right-angle VGA video cable to the blue video connector under the back of the display.

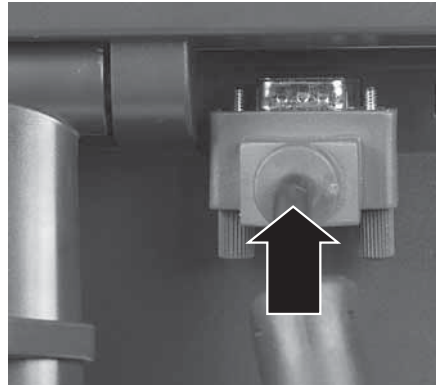

- 5 Make sure that your computer is turned off, then connect the other end of the video cable to the matching video port on the back of your computer.
- 6 Plug the power cord into a correctly grounded electrical outlet.

## Setting up the optional stand

### Attaching the USB stand

In the United States, you can buy an adjustable USB stand from Gateway at [www.gateway.com](http://www.gateway.com). The stand can be adjusted for height, tilt, and screen rotation. When connected to your computer's USB port, you can connect up to four USB devices to the USB 2.0 ports on the stand.

#### **To attach the adjustable stand:**

- 1 Make sure that the monitor is turned off.
- 2 Place the monitor face-down on a soft, non-marring surface. A non-slip mat on a tabletop is ideal. Let the monitor base hang down over the edge of the table.

- 3 Press the two release buttons on the back of the monitor's original neck, then slide the monitor base out of the neck.

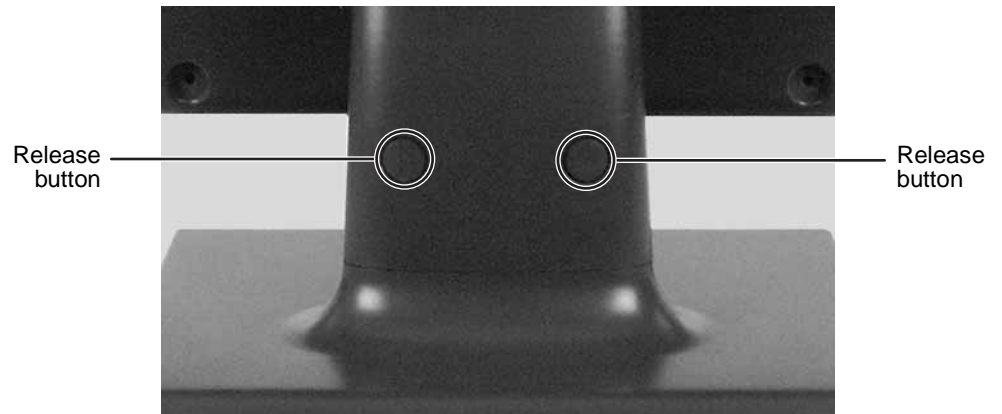

- 4 Remove the screw from the neck hinge, then remove the neck from the LCD panel.

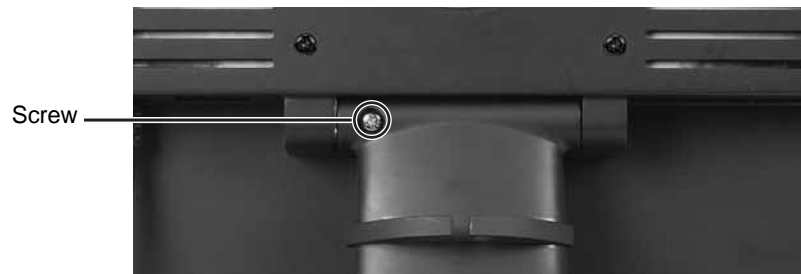

- 5 Remove the four small screws from the back of the LCD panel. Do not discard the four screws.



- 6 Slide the adjustable stand's neck onto the base.

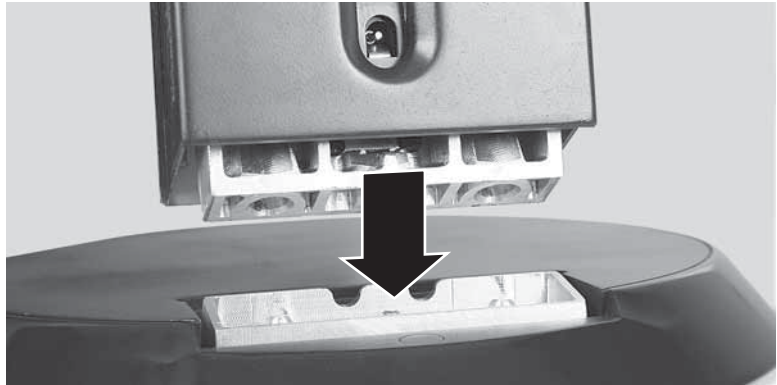

- 7 Tighten the thumbscrew under the base with your fingers (or a flat screwdriver) to secure the neck into place.

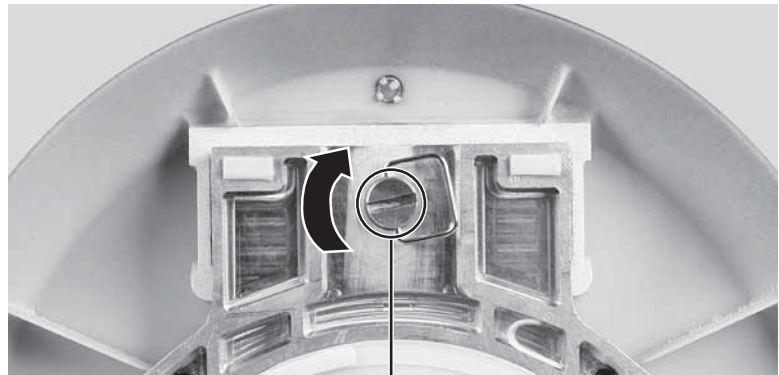

Thumbscrew

- 8 With the stand facing you, press the mounting bracket lever to the left and hold it, then remove the bracket from the stand.

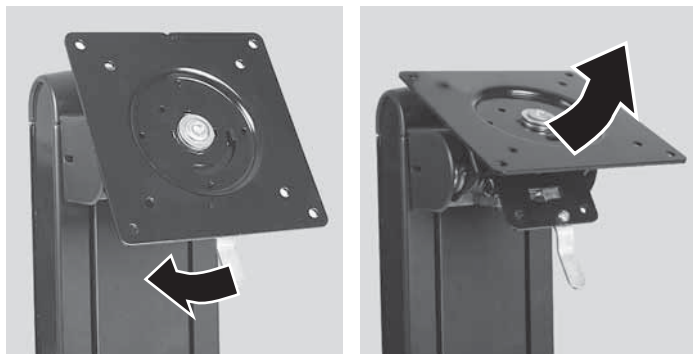

- 9 Attach the bracket to the LCD panel using the four screws you removed previously.

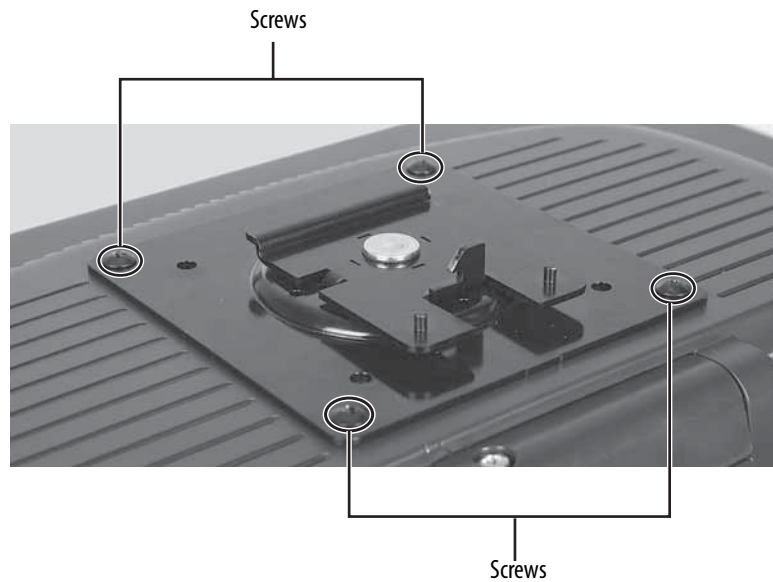

- 10 Slide the neck's bracket slot onto the bracket's mounting tab.

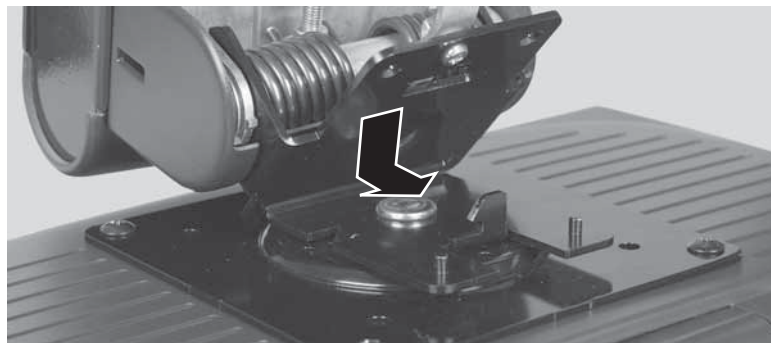

- 11 Press the bracket lever to the right and hold it, then lower the neck into place and release the lever.

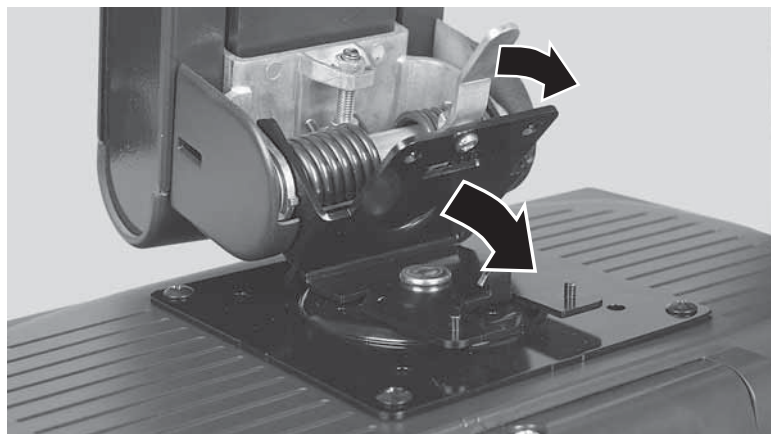

## Adjusting monitor height tension

The stand is factory adjusted to maintain the height for your monitor. However, if it does not stay in place when you let go, you need to change the stand's height tension. You also need to adjust the stand if the amounts of force required to raise and lower the monitor are not equal.

### ▶ To adjust your monitor's height tension:

- 1 Press the screwdriver access hole cap from below the base to remove it from the base.

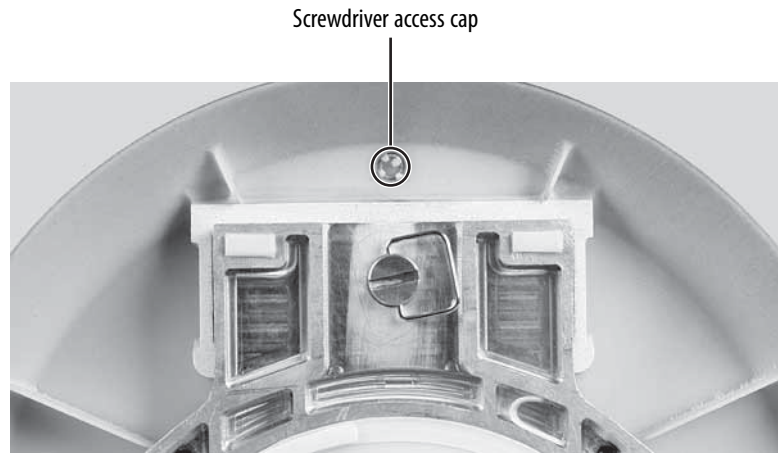

- 2 Insert a Phillips screwdriver through the access hole in the base and onto the height tension screw (on the back of the stand, in the slot above the USB In port).



- 3 Adjust the height tension screw so the monitor stays in place when you let go. If the monitor lowers by itself when you let go, turn the screw clockwise several complete turns. If the monitor rises when you let go, turn the screw counter-clockwise several complete turns. You may need to turn the screw several times before the tension is correct for your size of monitor.

- 4 Adjust the height tension screw so the raising and lowering forces are equal. After the forces are equalized, turn the tension screw clockwise two to four turns to slightly decrease the lifting tension.
- 5 For optimum viewing, adjust the height so the top of the monitor is about 1 inch (2.54 cm) below eye level.



## Adjusting monitor tilt tension



### To adjust your monitor's tilt tension:

- Adjust the tilt tension screw (on the top of the stand) so the monitor stays in place when you let go. If the monitor changes its tilt angle when you let go, turn the screw clockwise one complete turn to increase the tension.

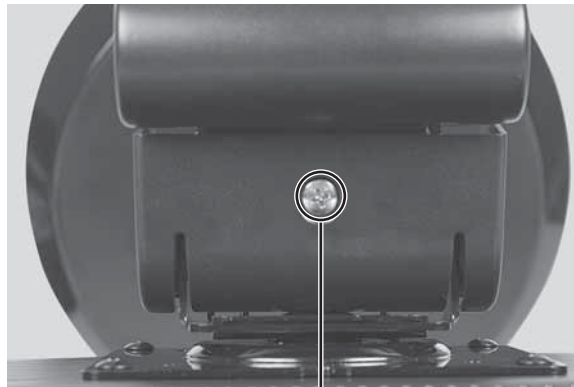

Tilt tension screw



## Ergonomic guidelines

The recommended screen positioning is based upon the following guidelines. These guidelines are based on available scientific literature and published standards.

### Screen height

The recommended screen height for displays (except in special circumstances, such as for bifocal use) is that the top of the display should be set at or slightly below (about 1 inch or 25 mm) your eye level while you are sitting in a comfortable working posture. This guideline places the center of the screen at an ideal 15° to 20° viewing angle for most desktop displays. If the display has multiple users, the screen height should be easily adjustable to accommodate each user's height and preference.

### Screen tilt

The screen should be tilted so your line of sight is perpendicular to the screen. This angle creates the most consistent viewing distance when scanning from the top of the screen to the bottom. You may need to adjust lighting to avoid screen glare when the screen is tilted upward.

### Screen distance from user

The screen should first be placed at arm's length from the user, then adjusted back and forth to suit individual preference.

## Connecting the USB hub

The optional USB stand has a built-in, 4-port, USB 2.0 hub. To use these USB connectors, you need to connect the hub to power and to your computer.

### ▶ To connect your USB stand's built-in USB hub:

- 1 Plug the included USB cable into the USB In port on the back of your USB stand and into a USB 2.0 port on your computer. If you connect the stand to a USB 1.1 port on your computer, the stand's USB hub operates in USB 1.1 mode.

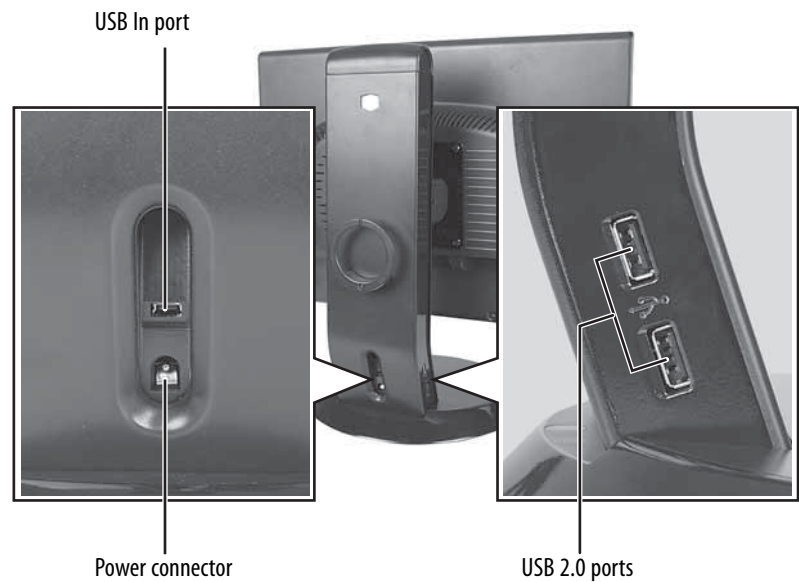

- 2 To provide full power to your stand's USB ports, connect the AC power adapter to the power connector on the back of your USB stand and into an AC power outlet.



## Setting up the optional speaker bar

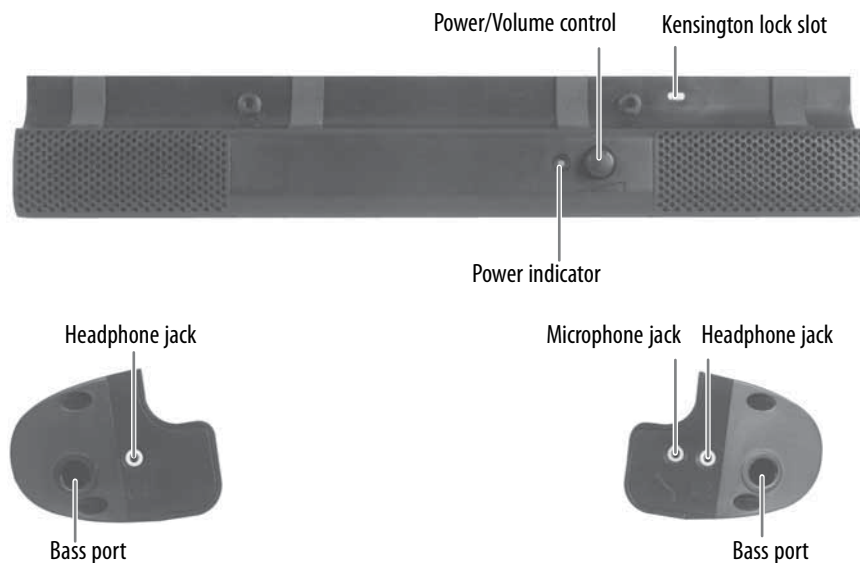

### Installing the speaker bar

#### Tips & Tricks

*When using the speaker bar, we recommend that you use the right-angle video cable so the speaker bar does not obstruct the cable.*

#### To install the speaker bar:

- 1 Tilt the screen back, then center the speaker bar below the screen. Make sure that the speakers face forward.
- 2 Tighten the two thumbscrews on the back of the speaker bar.



- 3 Connect the speaker bar's USB power cord to any available USB port on your computer or on the USB stand.
- 4 Connect the speaker bar's headphone (green) and microphone (pink) cables to your computer's headphone and microphone jacks.
- 5 If it is not already on, turn on your computer.

- 6 Turn on the speaker bar by rotating the power/volume knob clockwise.

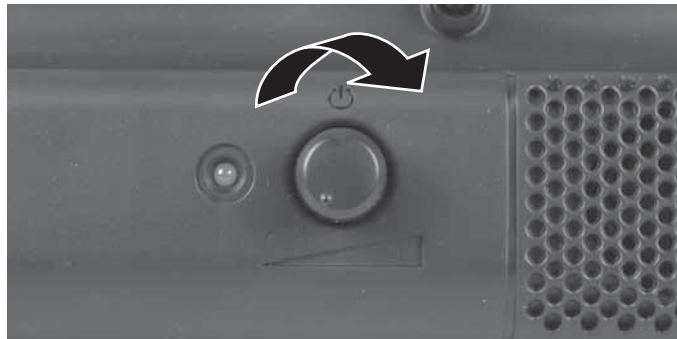

## Starting the monitor



### Important

The appearance of your monitor may vary from that shown.



### To start the monitor:

- 1 Press the power button on the front of monitor. The power LED on the power button turns on.

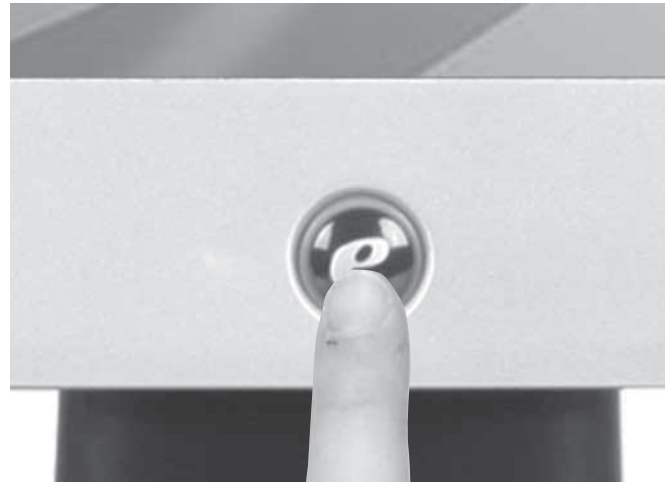

- 2 Turn on your computer.

After your computer is running, the power LED on the monitor's power button should be blue. Allow about 10 seconds for the monitor image to appear. If the power LED is not blue or you do not see a monitor image, check the connections. For more troubleshooting information, see "Troubleshooting" on page 21.

- 3 Adjust the tilt of the monitor for the best viewing angle.
- 4 After you see the Windows desktop, press the **Auto** button on the right side of the monitor to automatically adjust your monitor image to the ideal settings.
- 5 Use the on-screen display (OSD) to adjust other monitor settings. For more information, see "Adjusting monitor settings" on page 12.



### Important

When adjusting the monitor settings, always press the **Auto** button before entering the OSD. This will automatically adjust the monitor image to the ideal settings for the current screen resolution.

## Adjusting monitor settings

Use the monitor controls (located on the monitor itself) and computer controls (accessible through Windows) to adjust the monitor image. For more information about computer controls, see "Adjusting Windows display settings" on page 15.

### Monitor buttons

 **Important**  
The appearance of your monitor may vary from that shown.

This monitor features an on-screen display (OSD) that lets you adjust contrast, brightness, and other settings for the monitor. The monitor saves changes you make to the settings, even if you turn off the monitor.

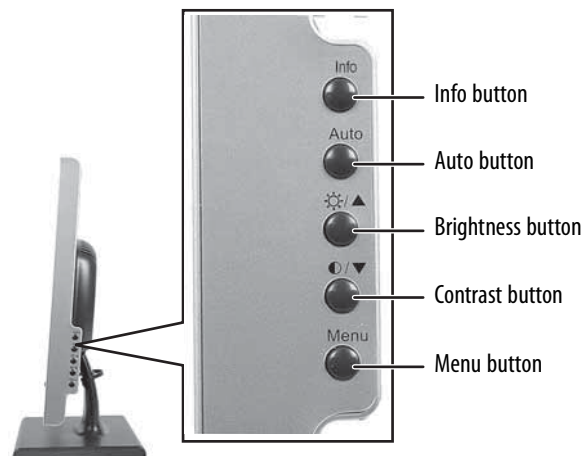

- **Info**  
OSD active: Press to move to the previous menu.  
OSD inactive: Press to display the current resolution and refresh rate of your monitor.
- **Auto**  
OSD active: Press to open a menu or setting.  
OSD inactive: Press to automatically optimize the monitor's image position, clock, and phase.
- **☀/△ (brightness)**  
OSD active: Press to move up through menu selections and adjust OSD options.  
OSD inactive: Press to adjust the brightness.
- **☀/▽ (contrast)**  
OSD active: Press to move down through menu selections and adjust OSD options.  
OSD inactive: Press to adjust the contrast.
- **Menu**  
Press to open the OSD. Press again to exit the OSD.

## On-screen display options

### Adjusting OSD settings



#### Tips & Tricks

While the OSD is active, on-screen labels appear next to the buttons to help you identify them.



#### To adjust the OSD settings:

- 1 Press the **Auto** button. The monitor image is automatically adjusted to the ideal settings for your current screen resolution.
- 2 Press the **Menu** button. The OSD menu opens.
- 3 Use the  $\Delta$  and  $\nabla$  buttons to highlight a setting, then press the **Auto** button to open the selected menu or setting.
- 4 Use the  $\Delta$  and  $\nabla$  buttons to adjust the setting to the desired level or change the option.
- 5 Press the **Info** button to return to a previous menu.
- 6 When you have finished making all adjustments, press the **Menu** button at the Main Menu to exit.

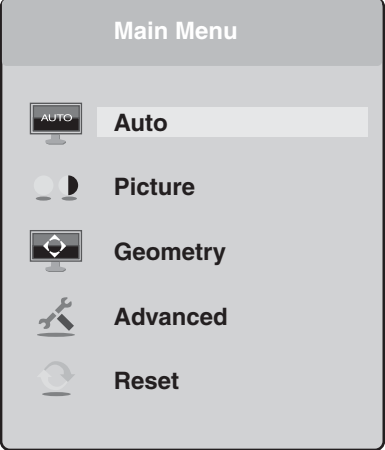
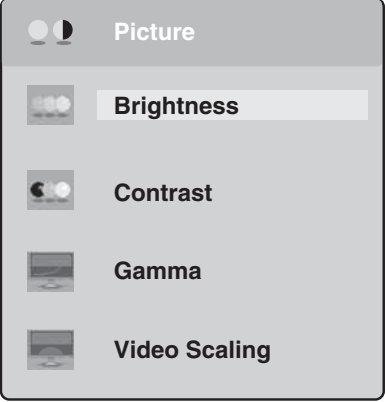
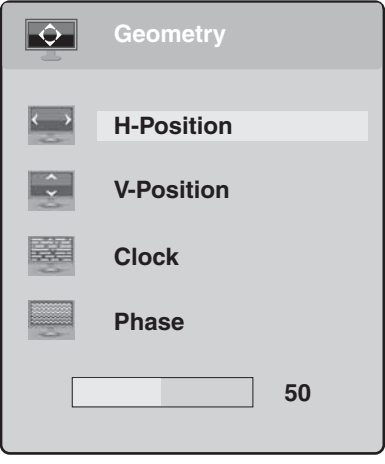

## OSD menus

OSD Menu	Description
<p data-bbox="167 310 315 338"><b>Main menu</b></p>  <p>The screenshot shows a grey OSD menu titled 'Main Menu'. It contains five options, each with a small icon to its left: 'Auto' (with an 'AUTO' icon), 'Picture' (with a sun/moon icon), 'Geometry' (with a monitor icon), 'Advanced' (with a wrench icon), and 'Reset' (with a circular arrow icon).</p>	<p><b>Auto</b>—Automatically adjusts your monitor to its optimum settings.</p> <p><b>Picture</b>—Opens the Picture menu, where you can adjust brightness, contrast, and gamma.</p> <p><b>Geometry</b>—Opens the Geometry menu, where you can adjust image size and minimize distortions.</p> <p><b>Advanced</b>—Opens the Advanced menu, where you can adjust color balance, change the OSD language, and display information about current monitor settings.</p> <p><b>Reset</b>—Resets the monitor to its factory settings.</p>
<p data-bbox="167 852 342 879"><b>Picture menu</b></p>  <p>The screenshot shows a grey OSD menu titled 'Picture'. It contains four options, each with a small icon to its left: 'Brightness' (with a sun/moon icon), 'Contrast' (with a sun/moon icon), 'Gamma' (with a monitor icon), and 'Video Scaling' (with a monitor icon).</p>	<p><b>Brightness</b>—Adjusts the amount of light in the darkest portion of the picture. Use the lowest brightness setting you are comfortable with to maximize the life of the monitor backlights. You may need to readjust brightness after the monitor has warmed up.</p> <p><b>Contrast</b>—Adjusts the level of white between the lightest and darkest portions of an image.</p> <p><b>Gamma</b>—Customizes the gamma level. High gamma levels increase white levels and low gamma levels increase contrast.</p> <p><b>Video scaling</b>—Adjusts the aspect ratio of the display.</p>
<p data-bbox="167 1329 380 1356"><b>Geometry menu</b></p>  <p>The screenshot shows a grey OSD menu titled 'Geometry'. It contains four options, each with a small icon to its left: 'H-Position' (with a left-right arrow icon), 'V-Position' (with an up-down arrow icon), 'Clock' (with a grid icon), and 'Phase' (with a grid icon). At the bottom of the menu is a horizontal slider bar with the number '50' to its right.</p>	<p><b>H-Position</b>—Moves the monitor image left and right.</p> <p><b>V-Position</b>—Moves the monitor image up and down. You can also press the <b>Auto</b> button to configure the vertical and horizontal position automatically.</p> <p><b>Clock</b>—Minimizes any vertical bars or stripes visible on the screen background. The horizontal screen size will also change.</p> <p><b>Phase</b>—Minimizes any horizontal distortion and clears or sharpens the displayed characters.</p>

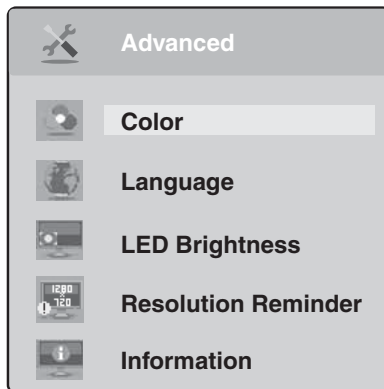
**OSD Menu****Description****Advanced menu**

**Color**—Customizes the color levels.

**Language**—Changes the language of the OSD.

**LED Brightness**—Changes the brightness of the Standby and Power LED to Day Mode or Nite Mode.

**Resolution Reminder**—If the computer display input is not set to 1280 × 720, displays a reminder that you should change your computer's settings to use the optimum 1280 × 720 resolution. If you prefer using your monitor at a resolution less than that, use this option to turn off the Resolution Reminder. For information on changing your computer's display resolution, see ["Adjusting Windows display settings"](#) on page 15.

**Information**—Displays current screen resolution.

## Adjusting Windows display settings

Color depth and screen resolution are two of the most basic monitor settings you may need to change to suit your needs. In Windows XP, you may also want to change the screen fonts setting.

*Color depth* is the number of colors your video card uses to display images on your monitor. Most images look best displayed with the maximum number of colors available. If the color in your images seems "false" or "jumpy," especially after you have played a game or run a video-intensive program, check the color depth setting and return it to the highest color setting, if necessary.

*Screen resolution* is the number of pixels (individual colored dots) your video card uses to display images on your monitor, and you can change it to your preference. The higher the resolution, the more information and screen components (such as icons and menu bars) can be displayed on the monitor.

*Screen fonts* are the fonts used for screen components such as icon labels, title bars, and dialog boxes. In Windows XP, you can change the display fonts to ClearType for smoother screen fonts. (Windows Vista already has ClearType selected by default.)

## Changing settings in Windows Vista

### **Help & Support**

For more information about adjusting monitor settings, click **Start**, then click **Help and Support**. Type **adjusting monitor settings** in the **Search** box, then click the magnifying glass.

### **To change the color depth or screen resolution:**

- 1 Click  (**Start**), **Control Panel**, then under **Appearance and Personalization** click **Adjust Screen Resolution**. The *Display Settings* dialog box opens.

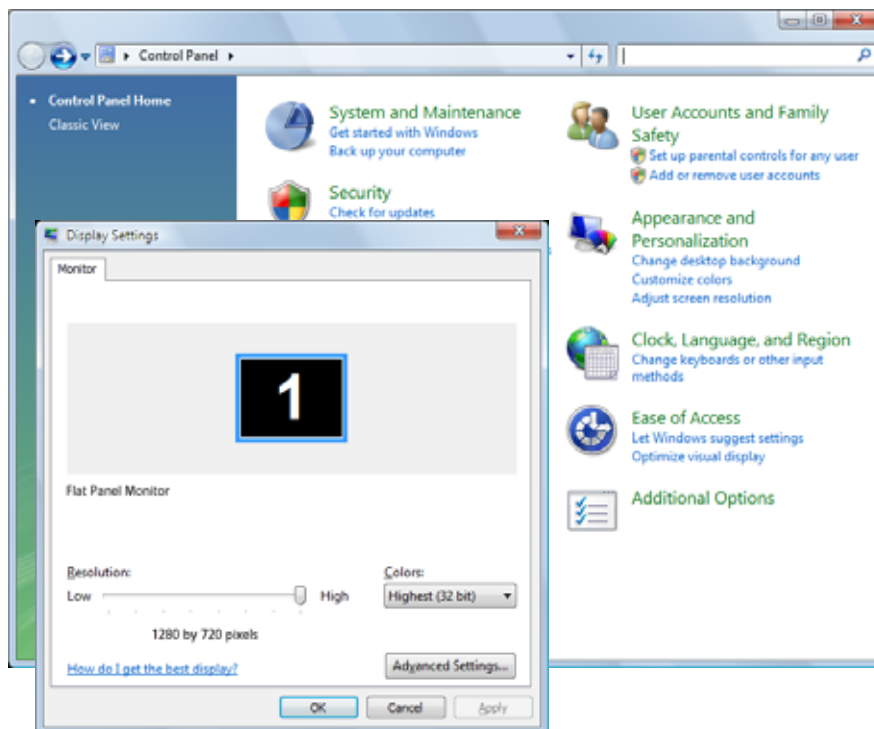

- 2 To change the color depth, click the **Colors** list, then click the color depth you want.
  - **Low (8-bit)** = 256 colors
  - **Medium (16-bit)** = 65,500 colors
  - **Highest (32-bit)** = 16,700,000 colors
- 3 To change the screen resolution, drag the **Resolution** slider to the size you prefer.
- 4 Click **Apply**. If the new settings do not look right, click **No**. If the new settings make the screen illegible and you cannot click **No**, the settings return to their previous values after several seconds.
- 5 Click **OK**, then click **Yes** to save your changes.



## Changing settings in Windows XP

### Changing the color depth or screen resolution

#### **Help & Support**

For more information about adjusting monitor settings, click **Start**, then click **Help and Support**. Type the phrase **changing display settings** or **changing screen resolution** in the **Search** box, then click the arrow.

#### **To change the color depth or screen resolution:**

- 1 Click **Start**, then click **Control Panel**. The *Control Panel* window opens. If your Control Panel is in Category View, click **Appearance and Themes**.
- 2 Click/Double-click the **Display** icon. The *Display Properties* dialog box opens.
- 3 Click the **Settings** tab.

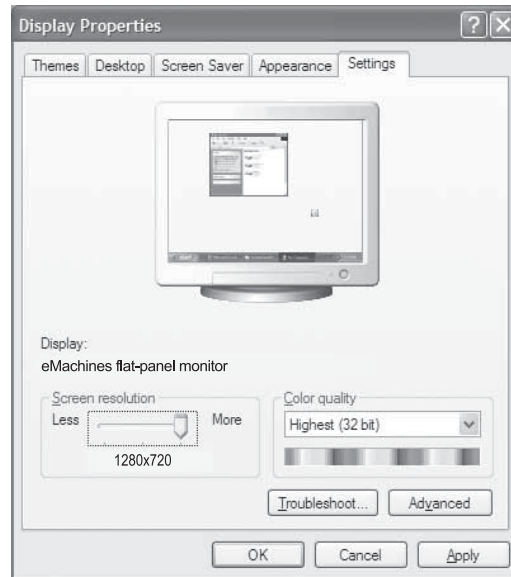

- 4 To change the color depth, click the arrow button to open the **Color quality** list, then click the color depth you want.
- 5 To change the screen resolution, drag the **Screen resolution** slider to the size you prefer.
- 6 Click **Apply**. If the new settings do not look right, click **No**. If the new settings make the screen illegible and you cannot click **No**, the settings return to their previous values after several seconds.
- 7 Click **OK**, then click **Yes** to save your changes.



### Clarifying screen fonts

You can change the display fonts to ClearType for smoother screen fonts.

#### **To change the display fonts to ClearType:**

- 1 Click **Start**, then click **Control Panel**. The *Control Panel* window opens. If your Control Panel is in Category View, click **Appearance and Themes**.

- 2 Click/Double-click the **Display** icon. The *Display Properties* dialog box opens.
- 3 Click the **Appearance** tab.

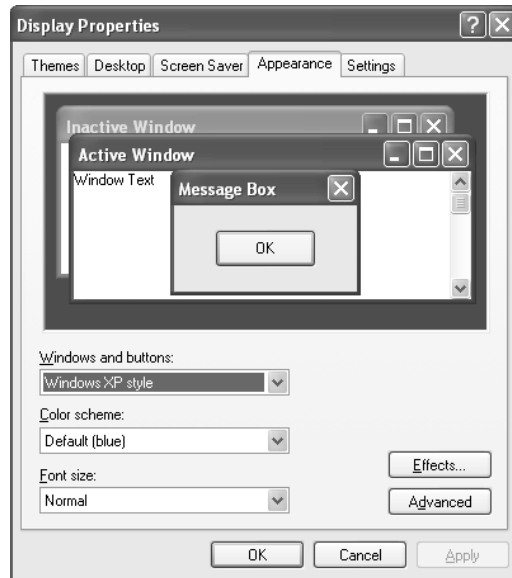

- 4 Click the **Effects** button. The *Effects* dialog box opens.
- 5 Click to select the **Use the following method to smooth the edges of screen type** check box.
- 6 Click the arrow to open the list, then click **ClearType**.
- 7 Click **OK**, then click **OK** again.



## Video modes

Your monitor supports several video modes. If you do not use the best mode for the monitor, the monitor image may look slightly "fuzzy."

Mode	Mode name and resolution	Horizontal frequency (kHz)	Vertical frequency (Hz)
1	VGA 720 × 400	31.469	70.087
2	VGA 640 × 480	31.469	59.941
3	VESA 640 × 480	37.861	72.810
4	VESA 640 × 480	37.500	75.000
5	VESA 800 × 600	35.156	56.250
6	VESA 800 × 600	37.879	60.317
7	VESA 800 × 600	48.077	72.188
8	VESA 800 × 600	46.875	75.000
9	VESA 1024 × 768	48.363	60.004
10	VESA 1024 × 768	56.476	70.069
11	VESA 1280 × 720	44.77	59.979

## Power management

### ENERGY STAR

As an ENERGY STAR® Partner, eMachines has determined that this product meets the ENERGY STAR guidelines for energy efficiency.

This monitor complies with the EPA's International ENERGY STAR Program, which is a program designed to encourage manufacturers of computer equipment to build circuitry into their products to reduce energy consumption during time of non-use.

## Energy declaration

When connected to a computer that supports the VESA Display Power Management Signaling (DPMS) Protocol, the monitor can conserve significant energy by reducing power consumption during periods of non-use. When your computer goes into the energy saving mode, the monitor will then enter the Active Off mode (sleep). In the Active Off mode the Power LED will still show orange.

Use these conventions and the power can be reduced to the following levels:

VESA State	LED Indicator	Power Consumption
On	Blue	<20 W
Active Off	Orange	<1 W

To “wake” the monitor when it is in Active Off mode, move the mouse or press any keyboard key.

Access the power management options in the Control Panel to change the period of time after which the monitor enters these low power states.

## Maintaining

To keep the monitor in optimal working order:

- Do not block the ventilation holes.
- Do not expose the monitor to rain or use near water.
- Keep the monitor away from radiators or heat vents.
- Keep the monitor out of direct sunlight.
- To clean the monitor, use a soft cloth slightly moistened with water only. Wipe the cabinet, screen, and controls.
- Storage specifications in this manual reflect design limitations, not recommended storage and humidity. We recommend that for extended periods of time (such as in the daily use environment), you store this monitor between 32~95°F (0-35°C) and humidity less than 70%.
- Make sure that the monitor is turned off before attaching the power and video cords.

### **Caution**

*Do not use any type of abrasive pad or glass cleaner. You will permanently scratch the screen.*

# Troubleshooting

**Important**

*Make sure that the monitor has warmed up for approximately 30 minutes before making any judgments about the picture quality.*

If you have problems with the monitor, the information in this troubleshooting section may help you solve them.

## No power

Make sure that the power cord is connected correctly to both the back of the monitor and the wall outlet. For more information about connecting the power cord, see "Connecting the monitor" on page 2.

## No picture

- Make sure that the power cord is connected correctly to both the back of the monitor and the wall outlet. For more information about connecting the power cord, see "Connecting the monitor" on page 2.
- Make sure that the video cable is connected securely to the back of the monitor and computer. For more information about connecting the video cable, see "Connecting the monitor" on page 2.
- Make sure that the monitor is turned on.
- If the power LED is orange:
  - Make sure that your computer is turned on.
  - Move the mouse or press any key on the keyboard to bring the monitor out of sleep mode.
  - Restart your computer with the monitor turned on.
  - Make sure that the video cable is not damaged.
  - Check the end of the video cable for any pins that might be bent or pushed in.
- Turn off the monitor and unplug the video cable from the back of your computer. Turn the monitor back on and wait for ten seconds. If the monitor is functioning correctly, a "No Signal" message appears. For more information about connecting the video cable, see "Connecting the monitor" on page 2.

## Monitor colors are wrong

- Press the **Auto** button to automatically adjust the monitor image to the ideal settings.
- Restart your computer with the monitor turned on.
- Make sure that the video cable is connected securely to the back of the monitor and your computer. For more information about connecting the video cable, see "Connecting the monitor" on page 2.
- Make sure that the video cable is not damaged.
- Check the end of the video cable for any pins that might be bent or pushed in.

## Picture has shadows or “ghosts”

- Press the **Auto** button to automatically adjust the monitor image to the ideal settings.
- Remove any extension cables or switchboxes.
- Make sure that the video cable is connected securely to the back of the monitor and your computer. For more information about connecting the video cable, see “Connecting the monitor” on page 2.
- Make sure that the video cable is not damaged.
- Check the end of the video cable for any pins that might be bent or pushed in.

## Color is not uniform

- Press the **Auto** button to automatically adjust the monitor image to the ideal settings.
- Make sure that the monitor warms up for at least 30 minutes before making a final judgment about color uniformity or brightness.

## Image is not sized or centered correctly

- Press the **Auto** button to automatically adjust the monitor image to the ideal settings.
- Use the position controls to adjust the image. For instructions on how to adjust the monitor image position, see “Adjusting monitor settings” on page 12.

## The monitor has pixels that are always dark or too bright

- This condition is normal and inherent in the TFT technology used in active-matrix LCD screens. eMachine’s inspection standards keep these to a minimum. If you feel these pixels are unacceptably numerous or dense on your monitor, contact eMachines Customer Care to identify whether a repair or replacement is justified based on the number of pixels affected.

## Speaker bar does not work

### I installed the speaker bar, but no sound is coming out of the speakers.

- Make sure that the speaker bar power cord is plugged into a USB port on the back of your computer or on the USB stand.
- Make sure that the volume control knob on the front of the speaker bar is turned on. Turn the knob clockwise to turn on the speakers and increase the volume. Turn the knob counter-clockwise to decrease the volume and turn off the speakers. The speaker bar’s power indicator lights blue when power is connected and the speakers are turned on.

**I checked all the connections and the speaker volume control is on, but I still do not get any sound.**

- Your headphone/speaker jack may have been muted using Windows sound controls. To check your headphone/speaker mute settings, click the speaker icon in the Windows taskbar, or click **Start, Control Panel, Sounds and Audio Devices**, the **Volume** tab, then click **Advanced**. For optimum volume control using the speaker bar, we recommend that you set the Windows volume mid-way between the lowest and highest setting.

**I want to plug in my headphones, but there is a headphone jack on both sides of the speaker bar. Which should I use?**

- You can use either jack or both jacks at the same time.

**The sound coming from the speakers sounds distorted.**

- Turn down the volume until the distortion disappears.
- Check the audio output volume of the sound device the speaker bar is connected to. If the audio device's output volume is set too high, the speaker bar's sound may always be distorted. To adjust the audio device's output volume, see the device's user guide. To adjust the volume in Windows XP, click the speaker icon in the Windows taskbar, or click **Start, Control Panel, Sounds and Audio Devices**, the **Volume** tab, then click **Advanced**. For optimum volume control using the speaker bar, we recommend that you set the Windows volume mid-way between the lowest and highest setting.

**I plugged my microphone into the speaker bar's microphone jack, but my computer cannot record any sound.**

- Make sure that the speaker bar's pink microphone plug is connected to the microphone jack on your computer.
- Your microphone jack may have been muted using Windows sound controls. To check your microphone's mute settings, click the speaker icon in the Windows taskbar, or click **Start, Control Panel, Sounds and Audio Devices**, the **Volume** tab, then click **Advanced**.

## Specifications

Specifications are subject to change without notice or obligation. Many products for eMachines are custom engineered by our suppliers to eMachines specifications and may vary from similarly marketed products.

<b>Panel size</b>	17 inches (diagonal widescreen)
<b>Panel type</b>	17-inch viewable TFT with anti-glare coating
<b>Pixel resolution</b>	1280 × 720 @60 Hz (native and maximum)
<b>Pixel pitch</b>	0.0115 × 0.0115 inches (0.291 mm × 0.291 mm)
<b>Aspect ratio</b>	16:9
<b>Brightness and contrast ratio</b>	250 cd/m <sup>2</sup> , 500:1
<b>Frequencies</b>	Horizontal: 30~60 KHz; Vertical: 56~76 KHz
<b>Viewing angles</b>	140° horizontal, 130° vertical
<b>Response time</b>	8 ms
<b>Lamp type/life</b>	40,000 hours
<b>Colors</b>	16.2 million Color temperature: 6500K
<b>OSD languages</b>	English, French, Spanish, Italian, Japanese
<b>Connections and inputs</b>	Analog (VGA): 15-pin mini d-sub VGA AC power
<b>Cables</b>	15-pin mini d-sub analog VGA (included)
<b>Power consumption</b>	Normal operation: 20 W Off (power-save): 1 W
<b>Power input</b>	100-240 VAC, 50/60 Hz
<b>Power management</b>	Energy Star®
<b>Certifications</b>	UL, cUL, FCC Class B, NOM, CE, CB, VCCI, Energy Star®, ROHS.
<b>Wall mount bracket</b>	VESA 3.937 inches (100 mm)
<b>Dimensions</b>	16.1 × 13.9 × 7.0 inches (40.89 × 35.31 × 17.88 cm) with stand
<b>Weight</b>	6.8 lbs. (3.08 kg)
<b>Temperature</b>	Operating: 41~95°F (5~35°C) Non-operating: -4~140°F (-20~65°C)
<b>Humidity</b>	Operating: 20~85% RH (non-condensing) Non-operating: 5~95% RH
<b>Altitude</b>	Operating: 9,843 ft (3,000 m) Non-operating: 32,808 ft (10,000 m)

## Safety, Regulatory, and Legal Information

- [Important safety information](#)
- [Environmental information](#)
- [Regulatory compliance statements](#)
- [Notices](#)

# Important safety information

## **Warning**

Always follow these instructions to help guard against personal injury and damage to your Gateway product.

Your Gateway product is designed and tested to meet the latest standards for safety of information technology equipment. However, to ensure safe use of this product, it is important that the safety instructions marked on the product and in the documentation are followed.

## Setting up your system

- Read and follow all instructions marked on the product and in the documentation before you operate your system. Retain all safety and operating instructions for future use.
- Do not use this product near water or a heat source such as a radiator.
- Set up the system on a stable work surface.
- The product should only be operated from the type of power source indicated on the rating label.
- If your product has a voltage selector switch, make sure that the switch is in the proper position for your area. The voltage selector switch is set at the factory to the correct voltage.
- Openings in the monitor case are provided for ventilation. Do not block or cover these openings. Make sure you provide adequate space, at least 6 inches (15 cm), around the system for ventilation when you set up your work area. Never insert objects of any kind into the monitor ventilation openings.
- Some products are equipped with a three-wire power cord to make sure that the product is properly grounded when in use. The plug on this cord will only fit into a grounding-type outlet. This is a safety feature. If you are unable to insert the plug into an outlet, contact an electrician to install the appropriate outlet.
- If you use an extension cord with this system, make sure that the total ampere rating on the products plugged into the extension cord does not exceed the extension cord ampere rating.
- If your system is fitted with a TV Tuner, cable, or satellite receiver card, make sure that the antenna or cable system is electrically grounded to provide some protection against voltage surges and buildup of static charges.

## Care during use

- Do not walk on the power cord or allow anything to rest on it.
- Do not spill anything on the system. The best way to avoid spills is to avoid eating and drinking near your system.
- Do not expose the monitor to rain or use near water. If the monitor does get exposed to moisture, unplug it and allow it to dry for 24 hours. Call Gateway Customer Care for advice on whether the monitor is safe to turn back on.
- When the monitor is turned off, a small amount of electrical current still flows through the monitor. To avoid electrical shock, always unplug all power cables and modem cables from the wall outlets before cleaning the system.
- Unplug the system from the wall outlet and refer servicing to qualified personnel if:
  - The power cord or plug is damaged.
  - Liquid has been spilled into the system.
  - The system does not operate properly when the operating instructions are followed.
  - The system was dropped or the cabinet is damaged.
  - The system performance changes.

## Replacement parts and accessories

Use only replacement parts and accessories recommended by Gateway.

## **Warning**

Do not use Gateway products in areas classified as hazardous locations. Such areas include patient care areas of medical and dental facilities, oxygen-laden environments, or industrial facilities.

# Environmental information

## Recycling

 **Mercury Warning**  
*Lamp(s) inside this product contain mercury and must be recycled or disposed of according to local, state, or federal laws.*

The product you have purchased contains extracted natural resources that have been used in the manufacturing process. This product may contain substances known to be hazardous to the environment or to human health.

To prevent releases of harmful substances into the environment and to maximize the use of our natural resources, Gateway provides the following information on how you can responsibly recycle or reuse most of the materials in your "end of life" product.

Waste Electrical and Electronic Equipment (commonly known as WEEE) should never be disposed of in the municipal waste stream (residential garbage collection). The "Crossed-Out Waste Bin" label affixed to this product is your reminder to dispose of your "end of life" product properly.



Substances such as glass, plastics, and certain chemical compounds are highly recoverable, recyclable, and reusable. You can do your part for the environment by following these simple steps:

- When your electrical or electronic equipment is no longer useful to you, "take it back" to your local or regional waste collection administration for recycling.
- In some cases, your "end of life" product may be "traded in" for credit towards the purchase of new Gateway equipment. Call Gateway to see if this program is available in your area.
- If you need further assistance in recycling, reusing, or trading in your "end of life" product, you may contact us at the Customer Care number listed in your product's user guide and we will be glad to help you with your effort.

Finally, we suggest that you practice other environmentally friendly actions by understanding and using the energy-saving features of this product (where applicable), recycling the inner and outer packaging (including shipping containers) this product was delivered in, and by disposing of or recycling used batteries properly.

With your help, we can reduce the amount of natural resources needed to produce electrical and electronic equipment, minimize the use of landfills for the disposal of "end of life" products, and generally improve our quality of life by ensuring that potentially hazardous substances are not released into the environment and are disposed of properly.

For additional recycling information specific to your area, please go to [www.gateway.com/recycle](http://www.gateway.com/recycle).

## EPA ENERGY STAR



As an ENERGY STAR® Partner, Gateway has determined that this product meets the ENERGY STAR guidelines for energy efficiency when used with a computer equipped with a Display Power Management System.

# Regulatory compliance statements

## United States of America

### Federal Communications Commission (FCC) Unintentional emitter per FCC Part 15

This device has been tested and found to comply with the limits for a Class B digital device, pursuant to Part 15 of the FCC rules. These limits are designed to provide reasonable protection against harmful interference in a residential installation. This equipment generates, uses, and can radiate radio frequency energy and, if not installed and used in accordance with the instructions, may cause harmful interference to radio or television reception. However, there is no guarantee that interference will not occur in a particular installation. If this equipment does cause interference to radio and television reception, which can be determined by turning the equipment off and on, the user is encouraged to try to correct the interference by one or more of the following measures:

- Reorient or relocate the receiving antenna
- Increase the separation between the equipment and receiver
- Connect the equipment to an outlet on a different circuit from that to which the receiver is connected
- Consult the dealer or an experienced radio/TV technician for help.

**Compliance Accessories:** The accessories associated with this equipment are: shielded video cable. These accessories are required to be used in order to ensure compliance with FCC rules.

### FCC declaration of conformity

#### Responsible party:

Gateway, Inc.  
7565 Irvine Center Drive  
Irvine, CA 92618 USA

This device complies with Part 15 of the FCC Rules. Operation of this device is subject to the following two conditions: (1) this device may not cause harmful interference, and (2) this device must accept any interference received, including interference that may cause undesired operation.



#### Caution

Changes or modifications not expressly approved by Gateway could void the FCC compliance and negate your authority to operate the product.



#### California Proposition 65 Warning

This product contains chemicals, including lead, known to the State of California to cause cancer, birth defects or reproductive harm.

## Canada

### Industry Canada (IC) Unintentional emitter per ICES-003

This digital apparatus does not exceed the Class B limits for radio noise emissions from digital apparatus as set out in the radio interference regulations of Industry Canada.

Le présent appareil numérique n'émet pas de bruits radioélectriques dépassant les limites applicables aux appareils numériques de Classe B prescrites dans le règlement sur le brouillage radioélectrique édicté par Industrie Canada.

# Notices

© 2006 Gateway, Inc.  
All rights reserved.

Gateway, Inc.  
7565 Irvine Center Drive  
Irvine, CA 92618 USA  
All Rights Reserved

This publication is protected by copyright and all rights are reserved. No part of it may be reproduced or transmitted by any means or in any form, without prior consent in writing from Gateway.

The information in this manual has been carefully checked and is believed to be accurate. However, changes are made periodically. These changes are incorporated in newer publication editions. Gateway may improve and/or change products described in this publication at any time. Due to continuing system improvements, Gateway is not responsible for inaccurate information which may appear in this manual. For the latest product updates, consult the Gateway Web site at [www.gateway.com](http://www.gateway.com). In no event will Gateway be liable for direct, indirect, special, exemplary, incidental, or consequential damages resulting from any defect or omission in this manual, even if advised of the possibility of such damages.

In the interest of continued product development, Gateway reserves the right to make improvements in this manual and the products it describes at any time, without notices or obligation.

## Trademark Acknowledgments

Gateway and eMachines are trademarks or registered trademarks of Gateway, Inc. in the United States and other countries. All other brands and product names are trademarks or registered trademarks of their respective companies.





MAN E17T4W USR GDE R0 10/06



8511810



8 27103 12462 0